

## INSTRUCTION MANUAL SEMI VERTICALS AND FULL HEIGHT MULTIDECKS

3335639-NR, 3335640-NR, 3335641-NR, 3335642-NR,  
3335643-NR, 3335644-NR, 3335645-NR, 3335646-NR,  
3335647-NR, 3335648-NR, 3335649-NR, 3335650-NR,  
3335651-NR, 3335652-NR, 3335653-NR, 3335654-NR,  
3335655-NR, 3335656-NR.



# CONTENTS

<b>1. PREFIX</b>	<b>4</b>
<b>2. IMPORTANT NOTES &amp; WARNINGS</b>	<b>4</b>
<b>3. PACKAGING AND HANDLING</b>	<b>5</b>
<b>4. PRODUCT OVERVIEW</b>	<b>6</b>
<b>5. INSTALLATION</b>	<b>10</b>
<b>6. SHELF AND BUMPER INSTALLATION</b>	<b>12</b>
<b>7. OPERATION</b>	<b>14</b>
<b>8. PRODUCT LOADING AND STORAGE</b>	<b>15</b>
<b>9. MAINTENANCE</b>	<b>15</b>
<b>10. TROUBLESHOOTING</b>	<b>17</b>
<b>11. MULTIPLEXING PROCEDURE</b>	<b>18</b>
<b>12. ALTERNATE CONFIGURATIONS</b>	<b>19</b>
<b>13. ENVIRONMENTAL AND DISPOSAL NOTES</b>	<b>19</b>
<b>14. WARRANTY</b>	<b>20</b>

# 1. PREFIX

This manual contains important information about the installation, operation, and maintenance of Bromic Semi-Vertical and Full-Height Multideck units. Please pay close attention to the important safety information shown throughout this instruction manual. Any safety information will be accompanied by the following safety alert symbols:

 DANGER,  WARNING,  IMPORTANT

- READ THIS MANUAL CAREFULLY before installing or servicing this product.
- Improper installation, operation, or maintenance can result in death, severe injury, or property damage.
- Improper installation, operation, or maintenance may also result in warranty being voided.
- This appliance is intended for 230-240 Volt power supply.
- Installation and maintenance MUST be carried out as per instruction, by a qualified technician in accordance with local regulation

## 2. IMPORTANT NOTES AND WARNINGS

- Read all instructions before installing or using this appliance
- Retain this manual for future reference
- Use this appliance only as described in this manual. Any other use not recommended by the manufacturer may cause fire, electric shock or injury.
- Improper installation, adjustment or alteration and failure to follow the warnings and instructions in this manual could result in severe personal injury, death or property damage
- The manufacturer is not responsible for any damage that could happen from improper use. The manufacturer emphasises that this appliance should be used in a responsible manner and that all procedures, warnings, and safety instructions contained in this booklet be followed strictly.
- Check the appliance for damage. Do not operate a damaged unit.
- Check for damage to the appliance regularly. If damage to the appliance is suspected, discontinue use immediately and contact the supplier or qualified person to repair.
- This appliance is not intended for use by people (including children) with reduced physical, sensory or mental capabilities, or lack of experience and knowledge, unless they have been given supervision or instruction concerning use of the appliance by a person responsible of their safety.
- Keep packaging material out reach of children
- Children should be carefully supervised to ensure that they do not play with the appliance
- Do not attempt to alter the appliance in any manner.
- Please pay attention to the maximum load limit (50 kg) when filling the shelves.
- All work on electrical equipment must be carried out by a qualified and licensed technician only.
- Do not perform maintenance until the appliance has been turned off and power disconnected.
- Never detach any cover except where specifically instructed in this manual. Doing so might expose live electrical parts.
- Do not operate the appliance with panels, covers or guards removed.
- Keep the air intake and outlets free of obstructions.
- Do not use the appliance outdoors.
- If the supply cord becomes damaged, it must be replaced by an authorised service agent or similarly qualified person in order to avoid a hazard.
- If the appliance has not been used, or will not be used for a long period of time, disconnect power supply.
- The appliance must be installed in accordance to AS1677.2:1998 to ensure there are no sources of ignition any area where refrigerant could gather in the event of a leak.
- Electrical equipment should not be placed under the unit or where refrigerant could gather in the event of a leak.
- Installation/servicing of the appliance must be performed by a licensed technician with Gas Work Authorization if the appliance gas system is being opened or charged.
- The refrigerant used in all appliances covered in this manual are flammable.



**Caution**  
**Risk of fire**

### 3. PACKAGING AND HANDLING

- This Multideck display contains fragile glass. The unit must always be handled with care.
- Adjust the width of forklift tines such that they line up with the structural supports on the Semi Vertical unit before lifting.
- The Semi Vertical unit must always be handled on flat and level ground.
- Take care not to damage the castors, while inserting forklift tines into the pallet.

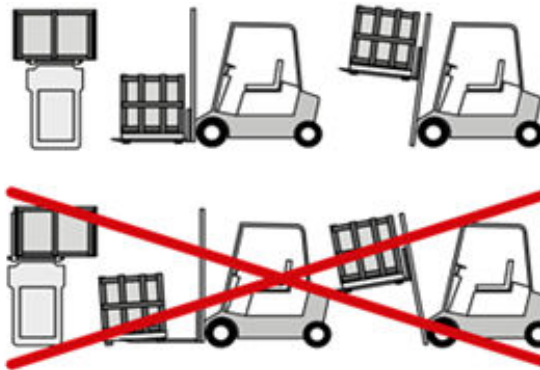

## 4. PRODUCT OVERVIEW

		SVM1000SD-NR	SVM1250SD-NR	SVM1580SD-NR	SVM1875SD-NR	SVM2500SD-NR
<b>Part Number</b>		3335644-NR	3335645-NR	3335648-NR	3335646-NR	3335647-NR
<b>External Dimension</b>	Height, mm	1500	1500	1500	1500	1500
	Width, mm	1022	1334	1580	1959	2584
	Depth, mm	775	775	775	775	775
<b>Volume</b>	L	332	443	559	664	885
<b>Unit Weight</b>	Kg	165	190	220	240	290
<b>Total Display Area</b>	m <sup>2</sup>	1.44	1.89	2.20	2.69	3.49
<b>Packaged Weight</b>	Kg	190	215	245	265	315
<b>Temperature</b>	Range	-1°C to +10°C	-1°C to +10°C	-1°C to +10°C	-1°C to +10°C	-1°C to +10°C
	Type	Digital	Digital	Digital	Digital	Digital
	Ambient	25°C	25°C	25°C	25°C	25°C
<b>Climate Class</b>	Rating	3M1	3M1	3M1	3M1	3M1
<b>Energy Consumption</b>	kWh/24h	2.6	3.1	4.1	4.6	6.9
<b>GEMS Star Rating</b>	Stars	10	10	9	9	8
<b>Refrigeration</b>	Refrigerant	580W	583W	340W	829W	842W
<b>Air Circulation</b>	Type	Fan Forced	Fan Forced	Fan Forced	Fan Forced	Fan Forced
<b>Refrigerant</b>	Type	R290	R290	R290	R290	R290
<b>Electrical</b>	Current, A	2.52	2.53	1.48	3.60	3.66
	Electrical, V	220-240	220-240	220-240	220-240	220-240
	Frequency	50Hz	50Hz	50Hz	50Hz	50Hz
	Power Supply	Single Phase	Single Phase	Single Phase	Single Phase	Single Phase
<b>Plug Supply</b>	Supplied	1 x 10A	1 x 10A	1 x 10A	1 x 10A	1 x 10A
	Plug Location	Rear	Rear	Rear	Rear	Rear
	Cord Length	2m	2m	2m	2m	2m
<b>Colour</b>	External	Black	Black	Black	Black	Black
<b>Internal Light</b>	Type	LED	LED	LED	LED	LED
	Colour Temp.	4000K	4000K	4000K	4000K	4000K
<b>Door</b>	No. of Doors	2	2	2	2	4
	Door Type	Glass	Glass	Glass	Glass	Glass
	Door Style	Sliding	Sliding	Sliding	Sliding	Sliding
	Door Lock	No	No	No	No	No
	Self-Closing	No	No	No	No	No
<b>Shelves Tiers</b>	No. incl. Base	4	4	4	4	4
	Type	Adjustable	Adjustable	Adjustable	Adjustable	Adjustable
	Dimensions, mm	933(w), 250(d), 300(d), 350(d)	1245(w), 250(d), 300(d), 350(d)	1570(w), 250(d), 300(d), 350(d)	1866(w), 250(d), 300(d), 350(d)	2490(w), 250(d), 300(d), 350(d)
<b>Air Curtain</b>	Y/N	Yes	Yes	Yes	Yes	Yes
<b>Castors</b>	Y/N	Yes	Yes	Yes	Yes	Yes

		<b>SVM1000HD-NR</b>	<b>SVM1250HD-NR</b>	<b>SVM1580HD-NR</b>	<b>SVM1875HD-NR</b>	<b>SVM2500HD-NR</b>
<b>Part Number</b>		3335639-NR	3335640-NR	3335643-NR	3335641-NR	3335642-NR
<b>External Dimension</b>	Height, mm	1500	1500	1500	1500	1500
	Width, mm	1022	1334	1580	1959	2584
	Depth, mm	825	825	825	825	825
<b>Volume</b>	Litres	332	443	559	664	885
<b>Unit Weight</b>	Kg	165	190	220	240	290
<b>Total Display Area</b>	m <sup>2</sup>	1.44	1.89	2.20	2.69	3.49
<b>Packaged Weight</b>	Kg	190	215	245	265	315
<b>Temperature</b>	Range	-1°C to +10°C	-1°C to +10°C	-1°C to +10°C	-1°C to +10°C	-1°C to +10°C
	Type	Digital	Digital	Digital	Digital	Digital
	Ambient	25°C	25°C	25°C	25°C	25°C
<b>Climate Class</b>	Rating	3M1	3M1	3M1	3M1	3M1
<b>Energy Consumption</b>	kWh/24h	2.6	3.1	4.1	4.6	6.9
<b>GEMS Star Rating</b>	Stars	10	10	9	9	8
<b>Refrigeration</b>	Refrigerant	580W	583W	340W	829W	842W
<b>Air Circulation</b>	Type	Fan Forced	Fan Forced	Fan Forced	Fan Forced	Fan Forced
<b>Refrigerant</b>	Type	R290	R290	R290	R290	R290
<b>Electrical</b>	Current, A	2.52	2.53	1.48	3.60	3.66
	Electrical, V	230V	230V	230V	230V	230V
	Frequency	50Hz	50Hz	50Hz	50Hz	50Hz
	Power Supply	Single Phase	Single Phase	Single Phase	Single Phase	Single Phase
<b>Plug Supply</b>	Supplied	1 x 10A	1 x 10A	1 x 10A	1 x 10A	1 x 10A
	Plug Location	Rear	Rear	Rear	Rear	Rear
	Cord Length	2m	2m	2m	2m	2m
<b>Colour</b>	External	Black	Black	Black	Black	Black
<b>Internal Light</b>	Type	LED	LED	LED	LED	LED
	Colour Temp.	4000K	4000K	4000K	4000K	4000K
<b>Door</b>	No. of Doors	2	2	2	4	4
	Door Type	Glass	Glass	Glass	Glass	Glass
	Door Style	Hinged	Hinged	Hinged	Hinged	Hinged
	Door Lock	No	No	No	No	No
	Self-Closing	Yes	Yes	Yes	Yes	Yes
	Swing Dimension, mm	425	575	740	425	575
	Total Depth of Door Open, mm	1165	1315	1480	1165	1315
<b>Shelves Tiers</b>	No. incl. Base	4	4	4	4	4
	Type	Adjustable	Adjustable	Adjustable	Adjustable	Adjustable
	Dimensions, mm	933(w), 250(d), 300(d), 350(d)	1245(w), 250(d), 300(d), 350(d)	1570(w), 250(d), 300(d), 350(d)	1866(w), 250(d), 300(d), 350(d)	2490(w), 250(d), 300(d), 350(d)
<b>Air Curtain</b>	Y/N	Yes	Yes	Yes	Yes	Yes
<b>Castors</b>	Y/N	Yes	Yes	Yes	Yes	Yes

		<b>FHM1000-NR</b>	<b>FHM1250-NR</b>	<b>FHM1875-NR</b>	<b>FHM2500-NR</b>
<b>Part Number</b>		3335649-NR	3335650-NR	3335651-NR	3335652-NR
	Height, mm	2090	2090	2090	2090
<b>External Dimension</b>	Width, mm	1018	1330	1955	2580
	Depth, mm	915	915	915	915
<b>Volume</b>	Litres	611	814	1222	1629
<b>Unit Weight</b>	Kg	270	336	468	600
<b>Total Display Area</b>	m <sup>2</sup>	2.16	2.73	4.06	5.6
<b>Packaged Weight</b>	Kg	300	370	500	640
	Range	-1°C to +10°C	-1°C to +10°C	-1°C to +10°C	-1°C to +10°C
<b>Temperature</b>	Type	Digital	Digital	Digital	Digital
	Ambient	25°C	25°C	25°C	25°C
<b>Climate Class</b>	Rating	3M1	3M1	3M1	3M1
<b>Energy Consumption</b>	kWh/24h	10.77	16.9	21.6	29.86
<b>GEMS Star Rating</b>	Stars	5	4	4	4
<b>Refrigeration</b>	Refrigerant	809W	1058W	1631W	2116W
<b>Air Circulation</b>	Type	Fan Forced	Fan Forced	Fan Forced	Fan Forced
<b>Refrigerant</b>	Type	R290	R290	R290	R290
	Current, A	3.52	4.6	7.09	9.2
<b>Electrical</b>	Electrical, V	230	230	230	230
	Frequency	50Hz	50Hz	50Hz	50Hz
	Power Supply	Single Phase	Single Phase	Single Phase	Single Phase
<b>Plug Supply</b>	Supplied	1 x 10A	1 x 10A	1 x 10A	1 x 10A
	Plug Location	Rear, bottom left	Rear, bottom left	Rear, bottom left	Rear, bottom left
	Cord Length	2m	2m	2m	2m
<b>Colour</b>	External	Black	Black	Black	Black
<b>Internal Light</b>	Type	LED	LED	LED	LED
	Colour Temp.	4000K	4000K	4000K	4000K
<b>Shelves Tiers</b>	No. incl. Base	4 + base	4 + base	4 + 4 + base	4 + 4 + base
	Type	Adjustable height & angle	Adjustable height & angle	Adjustable height & angle	Adjustable height & angle
	Dimensions, mm	933(w) x 500(d)	1245(w) x 500(d)	1866(w) x 500(d)	2490(w) x 500(d)
<b>Air Curtain</b>	Y/N	Yes	Yes	Yes	Yes
<b>Castors</b>	Y/N	Yes	Yes	Yes	Yes



		<b>FHM1000HD-NR</b>	<b>FHM1250HD-NR</b>	<b>FHM1875HD-NR</b>	<b>FHM2500HD-NR</b>
<b>Part Number</b>		3335653-NR	3335654-NR	3335655-NR	3335656-NR
<b>External Dimension</b>	Height, mm	2090	2090	2090	2090
	Width, mm	1018	1330	1955	2580
	Depth, mm	915	915	915	915
<b>Volume</b>	Litres	611	814	1222	1629
<b>Unit Weight</b>	Kg	270	336	468	600
<b>Total Display Area</b>	m <sup>2</sup>	2.16	2.73	4.06	5.6
<b>Packaged Weight</b>	Kg	300	370	500	640
<b>Temperature</b>	Range	-1°C to +10°C	-1°C to +10°C	-1°C to +10°C	-1°C to +10°C
	Type	Digital	Digital	Digital	Digital
	Ambient	25°C	25°C	25°C	25°C
<b>Climate Class</b>	Rating	3M1	3M1	3M1	3M1
<b>Energy Consumption</b>	kWh/24h	3.18	3.3	5.3	9.5
<b>GEMS Star Rating</b>	Stars	10	10	9	8
<b>Refrigeration</b>	Refrigerant	257W	276W	340W	581W
<b>Air Circulation</b>	Type	Fan Forced	Fan Forced	Fan Forced	Fan Forced
<b>Refrigerant</b>	Type	R290	R290	R290	R290
<b>Electrical</b>	Current, A	1.12A	1.20A	1.48A	2.52A
	Electrical, V	230	230	230	230
	Frequency	50Hz	50Hz	50Hz	50Hz
	Power Supply	Single Phase	Single Phase	Single Phase	Single Phase
<b>Plug Supply</b>	Supplied	1 x 10A	1 x 10A	1 x 10A	1 x 10A
	Plug Location	Rear, bottom left	Rear, bottom left	Rear, bottom left	Rear, bottom left
	Cord Length	2m	2m	2m	2m
<b>Colour</b>	External	Black	Black	Black	Black
<b>Doors</b>	Number	2	2	4	4
	Type	Glass	Glass	Glass	Glass
	Style	Hinged	Hinged	Hinged	Hinged
	Lock	No	No	No	No
	Self-Closing	Yes	Yes	Yes	Yes
	Swing Dimension, mm	469	625	469	625
<b>Shelf Tiers incl. Base</b>	Number	4 + base	4 + base	4 + 4 + base	4 + 4 + base
	Type	Adjustable height & angle	Adjustable height & angle	Adjustable height & angle	Adjustable height & angle
	Dimensions, mm	933(w) x 500(d)	1245(w) x 500(d)	1866(w) x 500(d)	2490(w) x 500(d)
<b>Internal Light</b>	Type	LED	LED	LED	LED
	Colour Temp.	4000K	4000K	4000K	4000K
<b>Air Curtain</b>	Y/N	Yes	Yes	Yes	Yes
<b>Castors</b>	Y/N	Yes	Yes	Yes	Yes

## 5. INSTALLATION

### Locating the Cabinet

Ensure the following instructions are observed as this is vital for proper and trouble-free operation.

- Do not install the cabinet outdoors.
- Locate the appliance in a dry and well ventilated place.
- The unit must be positioned on a level surface.
- Do not install in the vicinity of heating radiators or other heat sources.
- Do not install the appliance where it is exposed to direct sunlight.
- Do not install the appliance where it is exposed to warm draughts or open doors.
- Keep the air intake and outlets free of obstructions.
- Adequate allowance should be made for door openings.

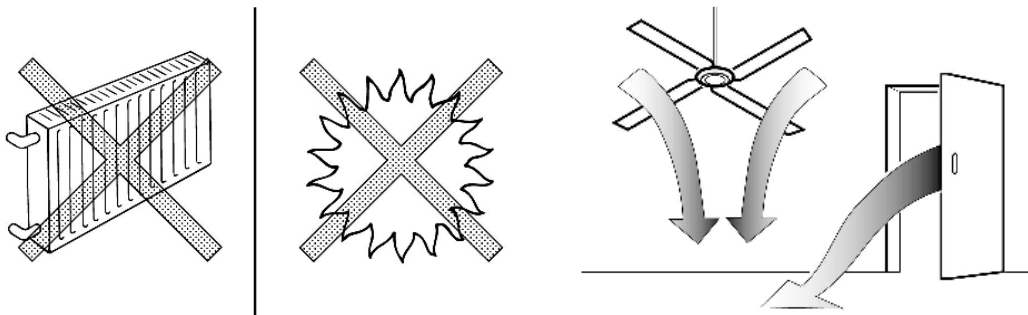

### Ventilation

- Allow 50mm clearance between walls and the appliance.
- Ensure that the condenser fan is free to take in ambient air from the room.
- Adherence to minimum clearances is necessary

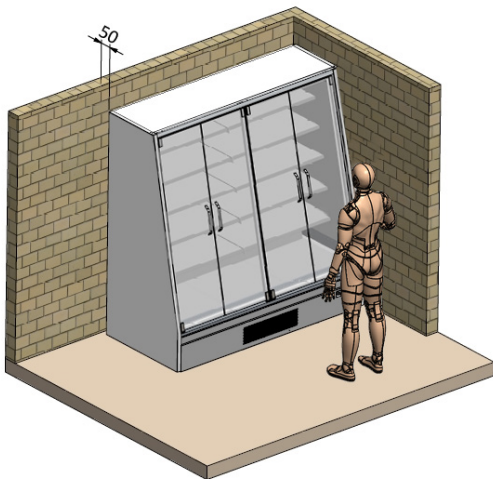

**NOTE:** The maximum ambient temperature for the refrigerator is 30°C. Conditions outside this temperature will result in cabinet temperatures outside the required 2 to 8°C range. Bromic recommends that the refrigerator is installed at an ambient temperature of 20 to 25°C.

## Power Supply

- The appliance must not be plugged into a multiple outlet power board.
- The appliance is supplied with a flexible power cord fitted with a 3-pin plug.
- The socket used must be properly earthed and fuse/RCD protected.
- See the rating label inside the cabinet for supply voltage, frequency and current draw.
- Power cable is rated 70°C. It is recommended that the cable should not come into contact with parts over 50°C.
- Do not turn off power before consulting the person responsible.
- Mark the power source clearly, so the refrigerator is not unplugged or turned off accidentally.

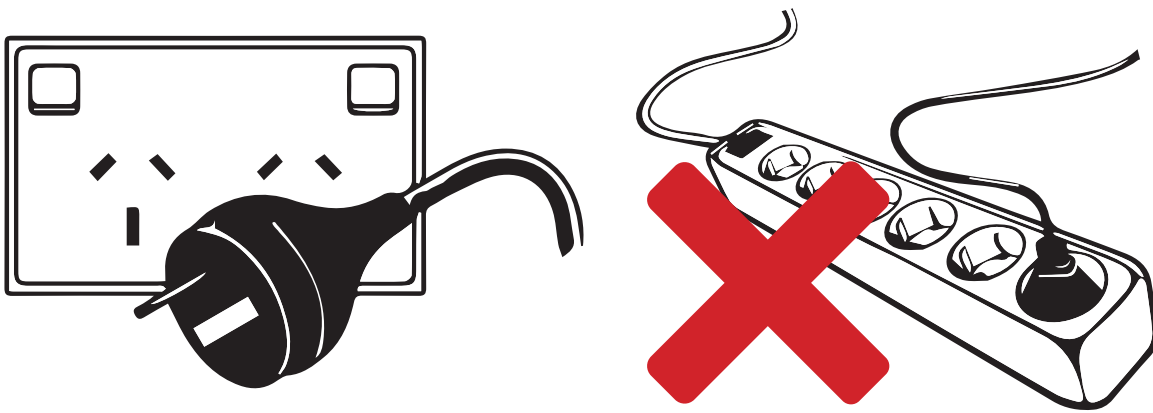

## Before Operating

- If the appliance has been sharply tilted or transported in the horizontal position, it must be left to stand in the upright position and not plugged in for at least 4 hours.
- Remove all the packaging material before using the appliance.
- Start the appliance only if it has been installed as described.

## 6. SHELF AND BUMPER INSTALLATION

### Shelf Installation

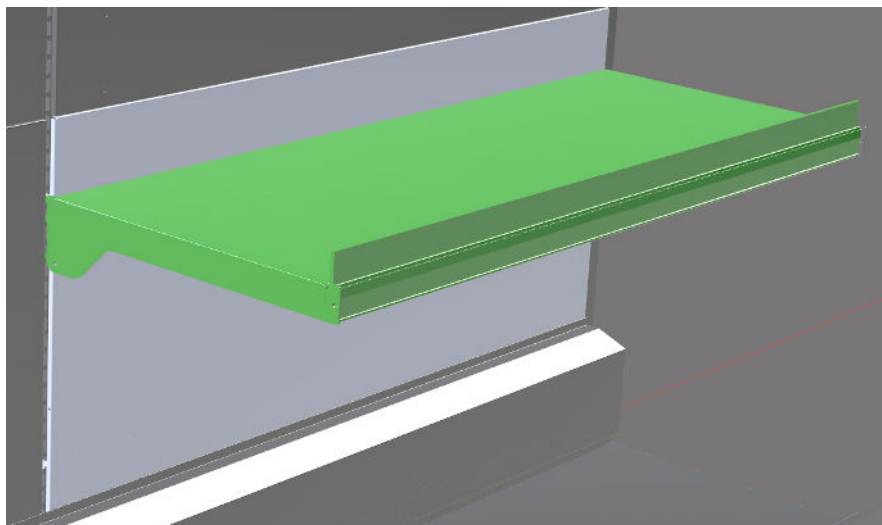
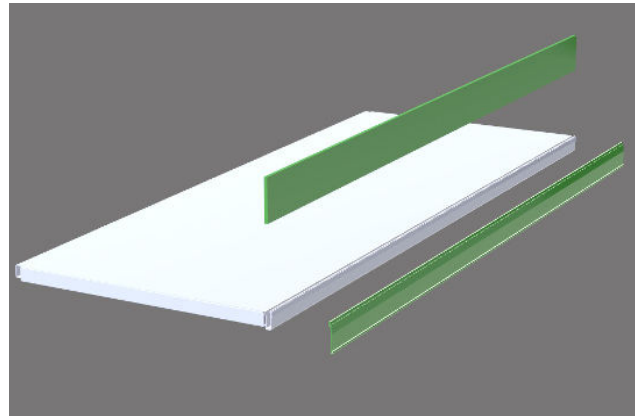
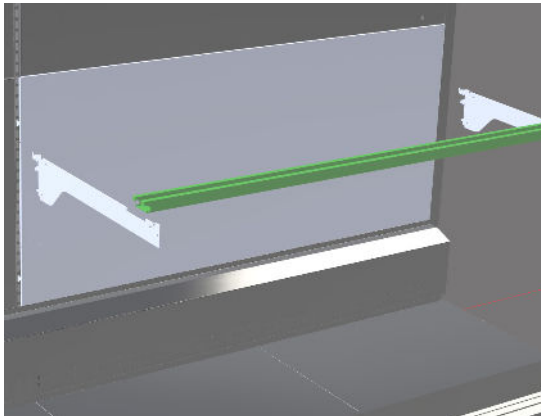
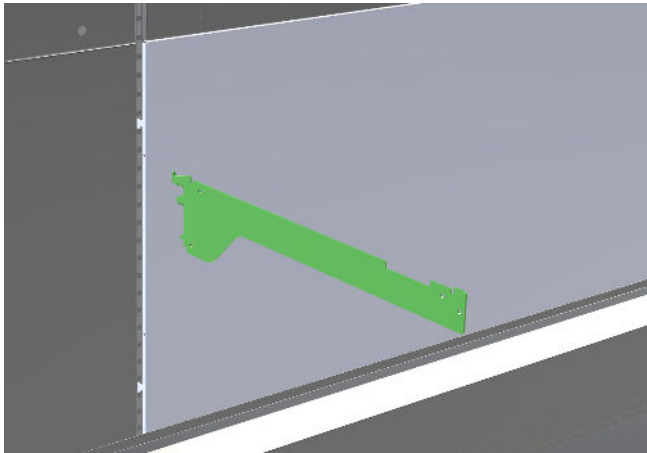

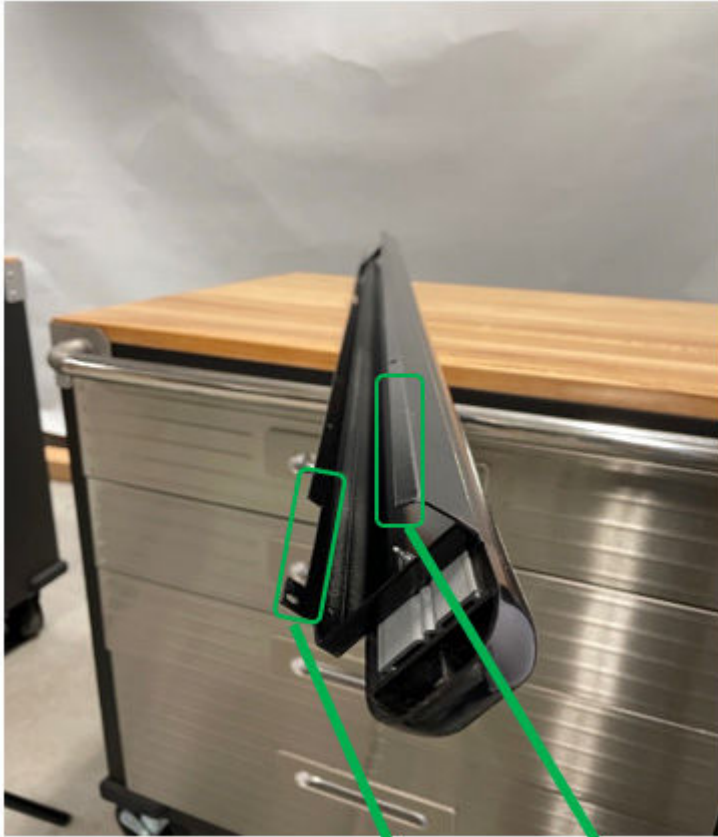

### Bumper Installation

1. Hook the top lip of the bumper against the top lip of the cabinet
2. Push the bottom of the bumper into the cabinet such that it locks in place. Do not be alarmed if it requires a large pushing force to lock the bumper in place.

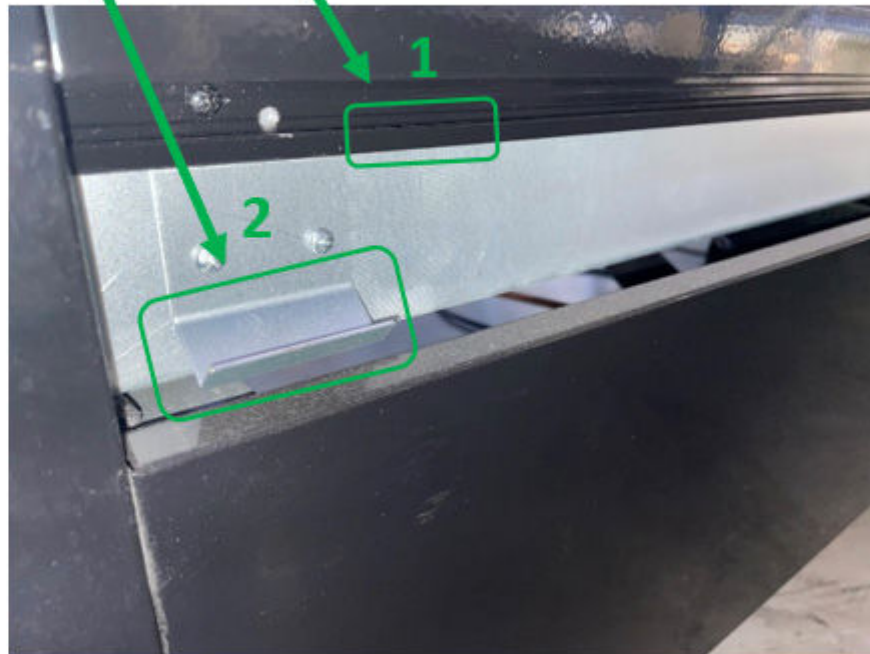

## 7. OPERATION

### Start-up

- Connect the appliance to the mains power supply and turn on the main switch (blue) by flipping it upward. Note that some models do not have the main switch (blue). In that case, simply proceed to the next instruction.
- The switches (image below) control cabinet cooling, glass heating, and lighting respectively. All switches should be flipped on for standard cabinet operation.
- Check that the electronic controller, lighting, and fans are operating correctly.
- The compressor and condenser fan should operate should operate within 3 minutes after the Refrigeration switch is turned on.
- The electronic controller will display the current cabinet temperature after the Refrigeration switch is turned on.
- The ❄️ LED indicates that refrigeration circuit is operating.
- During the start-up delay (3 minutes), the ❄️ LED is flashing
- The ❄️ LED indicates that the refrigeration circuit is defrosting

### Switches

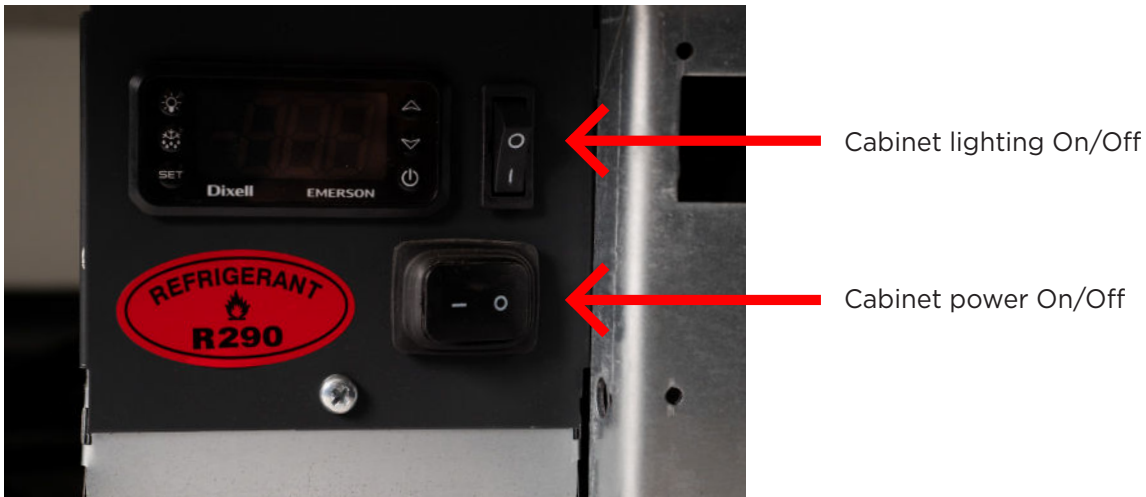

### Setting the temperature



- Press the **SET** button for more than 3 seconds.
- The value of the set point will be displayed and the '°C' or '°F' LED starts blinking.
- Press ▲ or ▼ arrow key within 10 seconds to adjust the set point.
- Press the **SET** key again or wait 10 seconds.

## 8. PRODUCT LOADING AND STORAGE



**IMPORTANT:** Run the refrigerator for at least 2 hours before loading.



**WARNING:** Do not store explosive substances such as aerosol cans with a flammable propellant inside the appliance.

### Start-up

- Clean the interior surface with a soft cloth and warm water before loading.
- Ensure there is free circulation of air between the products.
- Do not block the evaporator fan.
- Keep refrigerator door openings to a minimum.
- Some products are sensitive to ultraviolet (UV) light, please see storage guidelines from the manufacturer before removing from packaging.
- Do not block the top or bottom grills when loading the cabinet. This can reduce cooling performance.
- Do not overstock the cabinet: goods touching the cabinet walls and glass will not cool properly.

**NOTE: Bromic cannot be responsible for loss of stock or damage to stock.**

## 9. MAINTENANCE



**WARNING:** Disconnect the appliance from the power supply before performing any maintenance. Never unplug the appliance by pulling on the cord. Always grasp the plug firmly and pull straight out of the outlet.



**WARNING:** Exposure to significant water ingress will void warranty and cause potential safety issues. If the unit should be exposed to water, please contact the manufacturer immediately.

**IMPORTANT: Warranty may be void if there is no evidence of preventative maintenance is performed on the appliance.**

### Cleaning the Cabinet

- Remove the products and transfer to a suitable location prior to cleaning the inside of the cabinet.
- Do not use any aggressive or abrasive cleaning agents.
- Never use a water hose or a high-pressure jet to clean.
- Do not use sharp or pointed objects for cleaning.
- Clean the inside and outside of the appliance with a clean damp cloth or with a neutral cleanser.
- Dry all surfaces with a dry cloth.

### Condenser Coil/Filter



**IMPORTANT:** The filter and the condenser coil must be cleaned once a month. The condenser coil must be cleaned with vacuum/brush monthly to maintain the performance and minimise power consumption. A poorly maintained condenser coil can lead to failure of the unit and higher cabinet temperatures.

## General cleaning

- The multideck display must be wiped down regularly.
- Preventing the build-up of oil and sediments will increase the longevity of the unit.

## Condenser cleaning

- A clogged condenser can result reduced cooling performance.
- The condenser must be cleaned every 6 weeks.
- Recommended cleaning methods includes:
  - Vacuum cleaner
  - Cleaning brush
  - Compressed air

## Drain hose cleaning

- The drainage hose must be kept clean and clear.
- A clogged drainage hose can cause the unit to leak.

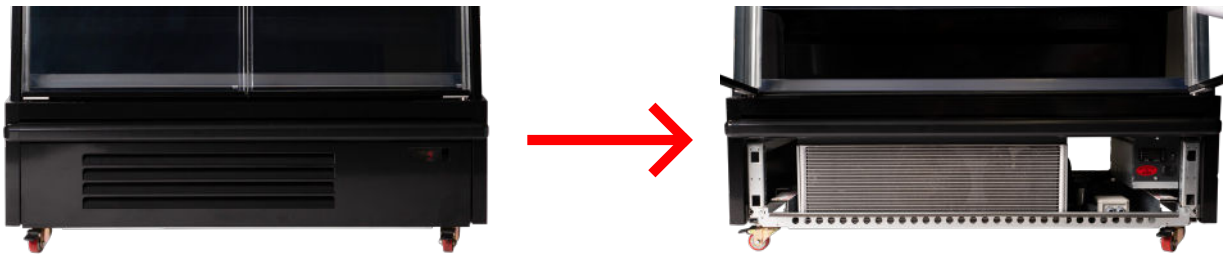

Remove front panel to access condenser. Ensure condenser is cleaned every 6 weeks.

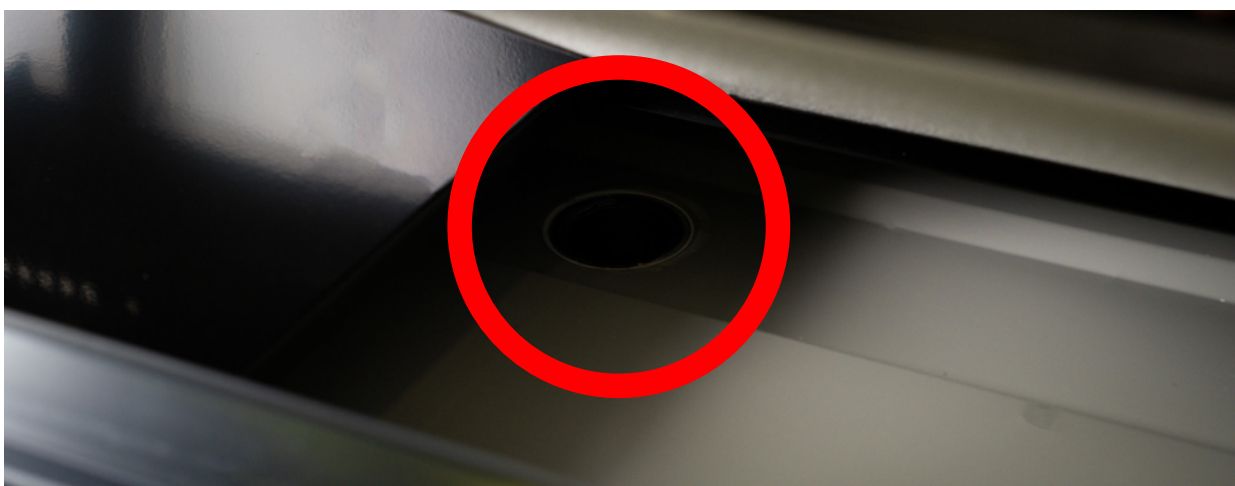

Base panels can be removed to access the drain pipe.



## 10. TROUBLESHOOTING



**IMPORTANT:** Repairs on the unit must be carried out by an authorised and licensed person only. Contact the manufacturer or an approved service agent for any repairs needed.

Symptom	Possible Cause(s)	Solution
Unit does not turn on	A. No power supply	A. i. Check that switch is on ii. Try plugging cabinet into different power sockets iii. Check power plug and cord for damage
Unit temperature too high	A. Incorrect controller set point B. Ambient temperature too high C. Inadequate ventilation D. Dirty condenser unit E. Ice build-up on evaporator coil	A. Change controller set point B. Ensure unit is in an air-conditioned environment of 25C C. Keep ventilation slots clear D. Clean the condenser coil and drain pipe E. Ensure drain pipe is not clogged with oil or waste
Unit temperature too low	A. Incorrect controller set point B. Ambient temperature too low C. Faulty evaporator probe	A. Change controller set point B. Ensure unit is in a temperature-controlled environment of 25C C. Contact Bromic service
Unit temperature greatly fluctuating	A. Cabinet is in direct sunlight or outdoors	A. Reposition cabinet such that it is not in direct sunlight or outdoors
Unit leaving water puddles on the ground	A. Cabinet glass is condensing and dripping B. Cabinet drip tray is overflowing	A. Ensure the cabinet is in an air-conditioned environment of 25C and 60% RH B. Contact Bromic service for diagnosis
Odour inside Unit	A. Rotting odour inside cabinet B. Oil or smoky odour	A. Clean the cabinet B. Turn off the cabinet and contact Bromic service immediately

# 11. MULTIPLEXING PROCEDURE

The multiplexing procedure can be used to connect multiple Bromic Semi Vertical units together.

- A Bromic multiplexing kit must be used for this procedure.
- The multiplexing procedure must be performed a licensed technician.

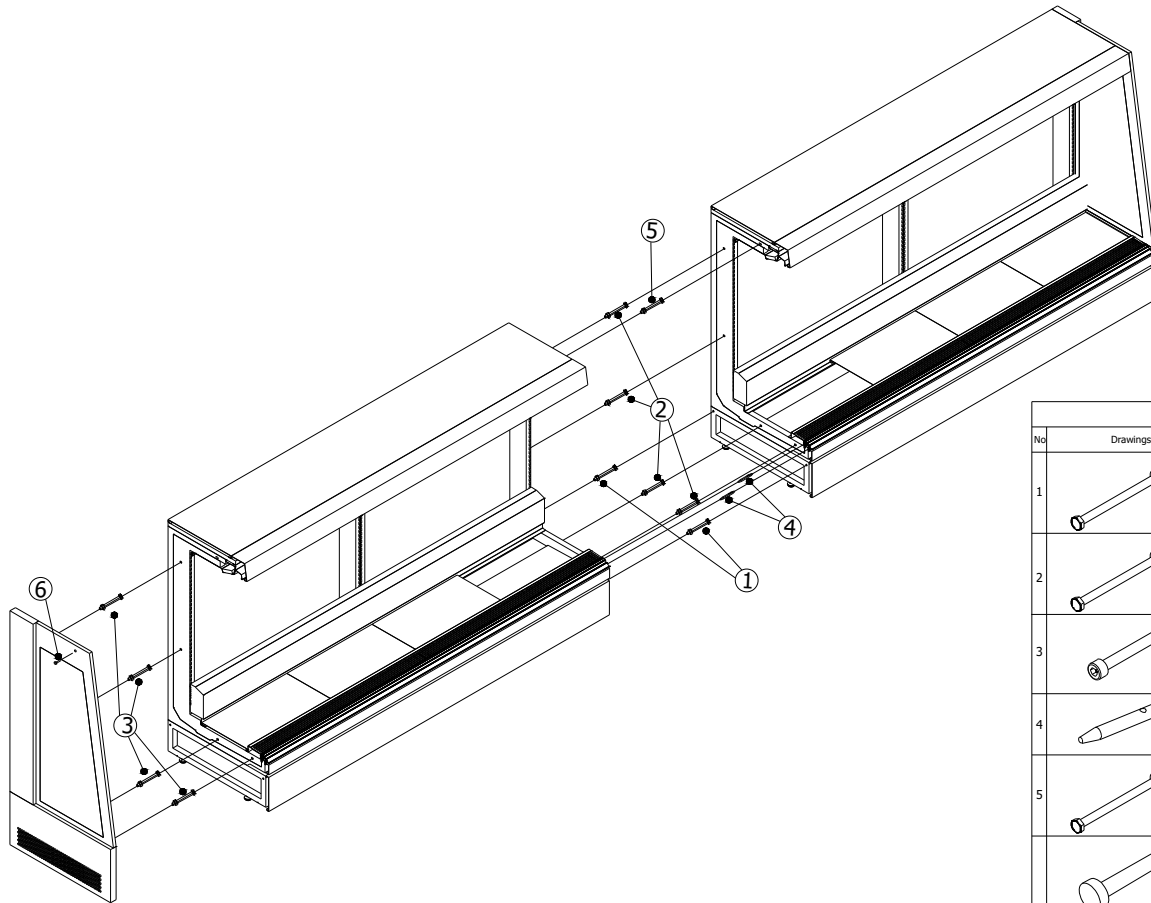

MULTIPLEXING (CABINET)			
No	Drawings	Parts	QTY
1		BOLT M8 x 120 WASHER M8 NUT M8	2
2		BOLT M8 x 100 WASHER M8 NUT M8	4
3		ALLEN BOLT M8 x 60 NUT M8	8
4		PIN Ø6 x 60	2
5		BOLT M8 x 170 WASHER M8 NUT M8	1
		BOLT M4 x 40	2

## 12. ALTERNATE CONFIGURATIONS

	Semi Vertical Multideck		Full Height Multideck	
	Default Configuration	Alternate Configuration	Default Configuration	Alternate Configuration
<b>Cabinet Depth</b>	740mm	880mm	880mm	740mm
<b>Door Options</b>	Hinged or Sliding door	Open front	Open front	Hinged door
<b>Colour Options</b>	Black painted interior and exterior	Alternate colours available upon special order	Black painted interior or exterior	Alternate colours available upon special order
<b>Undershelf Lighting</b>	4000K LED undershelf lighting	4000K LED undershelf lighting	No undershelf lighting	4000K LED undershelf lighting available

## 13. ENVIRONMENTAL AND DISPOSAL NOTES

These refrigerated cabinets are designed to high standards of environmental protection and recycling convenience. Cyclopentane, an environmentally friendly foaming agent, has been used. Cyclopentane is distinguished by zero ozone depletion potential (ODP) and zero global warming potential (GWP). The refrigerant used and contained within a hermetically tight circuit is environmentally friendly and does not contain chlorine and zero ODP.

The device must be disposed of in accordance with applicable regulations. The WEEE regulations must be observed.

In the interest of preventing environmental nuisance and promoting re-use of the high quality materials employed, used commercial refrigeration equipment must be collected for expert disposal and recycling. Therefore, observe the following disposal regulations:

- The cabinet must not be discarded with regular waste.
- The refrigeration circuit must not be damaged.
- Before disposal, make it unserviceable by disconnecting the power plug and cutting off the power cable.
- Consult your local authorities or authorised dealers for details of collection and disposal facilities.
- Children are often unable to recognise the dangers associated with commercial refrigeration equipment. Proper supervision must be maintained and children must be prevented from playing with discarded refrigerated cabinets.
- The refrigerant used in all appliances covered by this manual are flammable.



## 14. WARRANTY







All Bromic products are manufactured to the highest quality standard and are supported by our Extra Care Service Warranty, including guarantees against any material or workmanship defects; guarantees that cannot be excluded under Australian Consumer Law.





Warranty Terms vary across the range. Please ensure you are familiar with the Terms and Conditions that apply to the purchase of your Bromic product by referring to the Warranty Policy included with your purchased product.

Alternatively, you can also download the Warranty Policy at <https://www.bromicrefrigeration.com.au/support/warranty/>

## HOW TO PLACE A SERVICE REQUEST

- Please call 1300 276 642 to place a warranty service request and let the operator know whether you need Priority A or B service. More information can be found below.
- Ensure you have the serial number of your product ready before contacting us.
- The serial number of your product can be found on a compliance plate located on the inside right and at the rear of your cabinet.

P/N#3735161-NR				
Serial number:	Model:			
	<b>UC0650SD-NR</b>			
<b>ST21113A01GH65T004</b>	<b>Digital Thermostat Ventilated</b>			
Description	Power:			
<b>CHILLER UC0650SD-NR</b>	<b>AC220-240V 50Hz 1Ph</b>			
<b>UPRIGHT 1DR 650L S/S</b>	<b>MADE IN CHINA</b>			

BROMIC REFRIGERATION				
Serial no.:	<b>ST21113A01GH65T004</b>			
Climatic classification:	<b>4</b>	Insulation Blowing Gas	<b>C5H10</b>	
Bromic Model:	<b>UC0650SD-NR</b>	g	<b>120</b>	
Bromic Part no.:	<b>3735161-NR</b>	Hz	<b>50</b>	
Refrigerant type:	<b>R290</b>			
Rated Voltage:	<b>AC220~240V</b>	<b>MADE IN CHINA</b>		
Rated current:	<b>3.0A</b>			
Net Weight:	<b>135Kg</b>			
Rated Wattage:	<b>305W</b>			
Max Lamp Wattage:	<b>1.5W</b>			

Compliance Plate Example 1

## SERVICE REQUEST PRIORITY



### PRIORITY A SERVICE

When the unit is **NOT** performing its primary function such as cooling or heating, or presents an OH&S or food safety risk



### PRIORITY B SERVICE

When the unit is performing its primary function, and presents no OH&S or food safety risk. i.e. lights, gaskets, locks, door adjustment



### SERVICE CALL PLACED BEFORE MIDDAY

Priority A - Technician to attend site within 4 hours  
Priority B - Technician to attend site within 8 business hours



### SERVICE CALL PLACED AFTER MIDDAY

Priority A - Technician attends site before midday on the following business day  
Priority B - Technician attends site before 4pm on the following business day

**BROMIC REFRIGERATION**

10 Phiney Place, Ingleburn (Sydney)  
NSW 2565 Australia  
T. 1300 276 642

For further product information  
[bromicrefrigeration.com.au](http://bromicrefrigeration.com.au)